

Thermal management for electrical enclosures

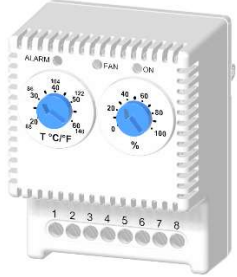

FSC1

FAN SPEED CONTROLLER User's manual

www.alfaelectric.com

WARNING

- Safety of FSC1 is warranted only by proper use of these instruction which must be kept.
- Installation must be done by qualified personnel only after power supply disconnecting
- Before any operation, switch off the power supply.
- Install the FSC1 only inside an electrical enclosure.
- Upstream of the electrical connection, an efficient disconnection system must be provided
- Protection against access to live parts must be warranty by installer.
- Don't install FSC1 in ambient with excessive moisture and dirt
- Installation position of FSC1 must be selected to ensure good ventilation. Take care that any internal components of enclosure don't obstruct air passage.
- Follow all technical data shown in this manual.

This manual contains the information necessary for the product to be installed correctly and also instructions for its maintenance and use; we therefore recommend that the utmost attention is paid to the following instructions.

Though this manual has been issued with the greatest care, ALFA ELECTRIC will not take any responsibility deriving from its use. The same applies to each person or Company involved in the issuing of this manual.

This document is the exclusive property of ALFA ELECTRIC which forbids any reproduction and divulgation, even in part, of the document, unless expressly authorized. ALFA ELECTRIC reserves the right to make any formal or functional changes at any moment and without any notice.

1 - DESCRIPTION

GENERAL DESCRIPTION

Electronic temperature-regulated fan speed controller for DIN 35 mm. rail mounting.
Speed controller helps to reduce fan noise, air flow rate is reduced to the optimum speed required.
Standard version is fitted with thermal probe inside of casing. External probe available on request, it must be connected to dedicated terminals (7-8).

	FSC1
Power supply	100-230V 50/60Hz
Fan voltage rating	100-230V 50/60Hz
Temperature setting range	20-60°C
Max output fan	550W
Operating temperature	-10/+60°C
Conformity	CE

2 - INSTALLATION

2.1 GENERAL DESCRIPTION

FSC1 is fitted by clip for DIN rail 35mm mounting.

2.2 INSTALLATION

WARNING

- Install vertically (cables below controller) inside of electrical enclosure where temperature control is requested. (in case of FSC1 without external probe)
- Do not mount FSC1 near heat sources which could influence the proper temperature sensing.
- Do not operate in corrosive ambient air.
- Install FSC1 only in an electrical enclosure

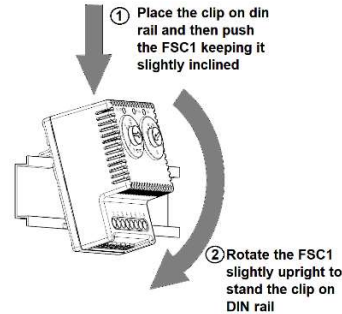

3 - REMOVAL

- Before any operation, switch off the power supply

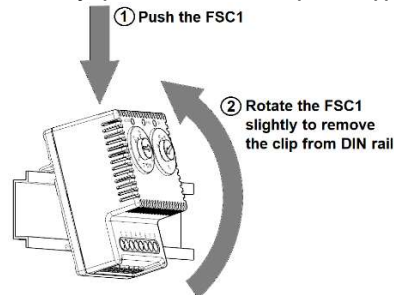

4 –ELECTRICAL CONNECTION

4.1 GENERAL DESCRIPTION

FSC1 must be powered at voltage rating shown on label pasted on casing side

4.2 ELECTRICAL CONNECTION

FSC1 connection must be done by trained electricians according national electrical safety codes.

- Before any operation, disconnect cabinet
- Connect the FSC1 to the power supply by adequate section cable according to dimension allowed by terminal.
- Connect FSC1 according to wiring diagram below

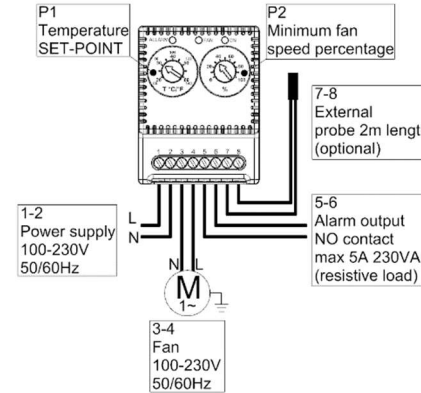

FSC1 terminals are suitable to connect wires up to 2,5mm² section

4.3 FAN CONNECTION

FSC1 can drive more than one fan simultaneously and it can drive max 550W output.

In case of more than one fan simultaneously driven, a filter capacitor (C1) must be connected

WARNING: FSC1 voltage supply must be the same of fan voltage rating

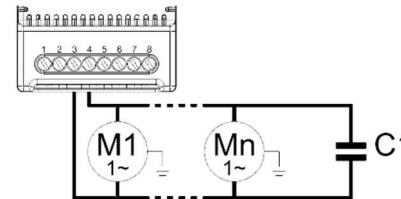

Capacitor capacity must be selected according to output driven power.

C1 capacity selection

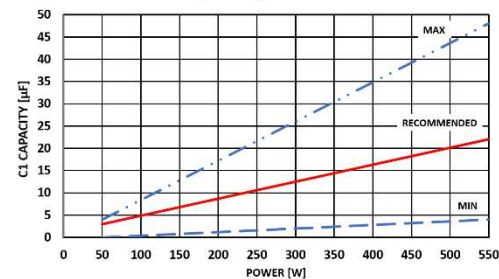

5 –FUNCTIONING

5.1 GENERAL DESCRIPTION

FSC1 is particularly designed to drive ALFAELECTRIC fans, filter fan units and roof fans unit.

The fan speed is automatically adjusted according to parameters below:

- 1) Inside enclosure temperature;
- 2) Temperature SET-POINT
- 3) Minimum fan speed percentage

Upon rising of the temperature 5°C below the set-point, the fan starts to rotate (minimum speed set in percentage).

The fan speed will increase proportionally to the temperature rising, and it reaches its top speed in correspondence to temperature SET POINT.

If inside enclosure temperature exceeds the SET-POINT value by 5°C, the alarm relay is triggered and it opens at setpoint value + 1°C.

If the temperature decreases, the fan speed slow down and eventually stop at 5°C below the temperature SET-POINT.

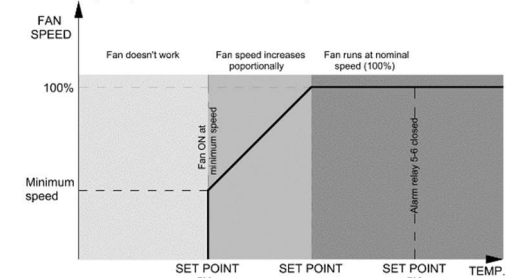

5.2 SETTING

NOTE: during the setting, environmental temperature must be higher than 20°C.

- 1) Set minimum fan speed percentage (P2) to 100% and P1 to 60°C.
- 2) Reduce P1 until the fan starts running, Reduce P2 to the minimum required speed.
- 3) Set P1 to required set point.

5.3 LED SIGNALING

FSC1 is fitted with 3 led for status signaling:

- 1) ALARM. Red LED for alarm signaling, it flash when temperature exceeds 5°C set point. Alarm reset at set-point value + 1°C.
- 2) FAN. Blue LED, it flashes when fan starts to work and it flashes with a frequency proportional to fan speed. It stay ON at 100% fan speed.
- 3) ON. Green LED, it turn on when FSC is powered.

6 – CLEANING, MAINTENANCE AND DISPOSAL

Cleaning and maintenance must be done only by specialized people after switching off power supply.

For cleaning use only a wiper and compressed air.

FSC1 must be disposed of separately from ordinary household wastes